

PC-3000X

PUMP CONTROLLER



User Manual







TABLE OF CONTENTS

Warnings	1
Introduction and Specifications	2
Main Screen (Programming).....	3
User Interface.....	3
Alternation	4
Level Setpoints.....	4
Counts and ETMS.....	5
Level Simulation.....	6
Advanced Settings	7
Remote Fault Status	11
I/O Status Screens.....	11
Pump Down Operation.....	12
Pump Up Operation	14
Level Alarms	15
Pump On/Off Delay Timers.....	15
Pump Start Failure Detection and External Disable Inputs	15
Setpoint Dwell Time	16
Alarms (Definition and Fixes).....	16
PC-3000X Power Up Screen	18
I/O Terminal Configuration.....	18
PC-3000X I/O Table.....	19
MODBUS Communication	20
MODBUS Registers	21
Mounting Dimensions.....	22
Controller Dimensions.....	23
Retrofit Replacement of a PC-3000.....	24
Electrical Wiring Diagram.....	26
PC-3000X Controller Setpoints List	27

WARNINGS

Failure to read and understand the information provided in this manual may result in personal injury or death, damage to the product or product failure. Please read each section in its entirety and be sure you understand the information provided in the section and related sections before attempting any of the procedures or operations given.

<p>Failure to follow these precautions could result in serious injury or death. Keep these instructions with warranty after installation. This product must be installed in accordance with National Electrical Code, ANSI/NFPA 70 so as to prevent moisture from entering or accumulating within the controller housing.</p>	
	<p>WARNING ELECTRICAL SHOCK HAZARD</p> <p>A qualified service person must install and service this product according to applicable codes and electrical schematics. Disconnect power prior to servicing any equipment with the PC-3000X controller.</p>
	<p>A qualified service person must install and service this product according to applicable codes and electrical schematics. Disconnect power prior to servicing any equipment with the PC-3000X controller.</p>
<ul style="list-style-type: none">• Do not connect power to this equipment if it has been damaged or has any missing parts.• The PC-3000X contains no serviceable parts; do not attempt to repair this equipment.• Do not install in areas with: excessive or conductive dust, corrosive or flammable gas, moisture or rain, excessive heat, regular impact shocks, or excessive vibration.	
	<p>WARNING EXPLOSION OR FIRE HAZARD</p> <p>Do not use this product with flammable liquids. Do not install in hazardous locations as defined by National Electrical Code, ANSI/NFPA 70.</p>
	<p>Do not use this product with flammable liquids. Do not install in hazardous locations as defined by National Electrical Code, ANSI/NFPA 70.</p>

Note: The float backup options talked about in this manual provide a backup for a level transmitter failure only. They are integral to the PC-3000X controller, and do not provide backup operation in the event of total controller failure. A separate backup alarm float should always be used.

INTRODUCTION & SPECIFICATIONS

Congratulations, and thank you for your purchase of the PC-3000X controller. This manual explains the features and operations of the PC-3000X controller which was designed to operate up to 3 pumps in a pump-up or pump-down application. The controller sequences pumps on and off in response to a change in level input. When used to control the level in a tank, the input is connected to a 4-20 mA pressure transmitter or ultrasonic transmitter. A rotary selector wheel is included along with back and escape pushbuttons for intuitive menu navigation and quick setting adjustments.

GENERAL

One, two or three pump controller
Pump up or pump down
Configurable units
Operates using 4-20mA level transmitter
Scalable 4-20mA output
Input for Transducer back up float switch
Rotary selector for menu navigation
2.7" blue OLED 64 x 256 pixel display

DIMENSIONS

7.2 x 5.3 x 2.0 inches

PUMP CONTROL AND PROTECTION

Automatic pump alternation
Multiple alternation configurations
Pump seal fail detection
Pump overtemp detection
Pump fail to start
Pump run indication
Constant or variable speed

SYSTEM

Cycle counter/hour meters

- Alarm counts
- Number of starts for each pump
- Run time for each pump

Level simulation

ELECTRICAL SPECIFICATIONS

Power

- 24 VDC Class 2 (19-28VDC, 325 mA max)
- Optional battery backup

Dedicated I/Os

- 11 digital inputs
- 6 relay outputs (120 VAC, 3A Max.)
- 1 analog input (4-20mA, 14 bit resolution, non isolated)
- 1 analog output (4-20mA, 12 bit resolution, non isolated, fully scalable)

Serial Communication Port

- RS-485 3-Wire (half duplex)
- Modbus RTU
- 9600 baud, 1 stop bit, no parity
- Designed for complete compatibility with the PRIMEX PumpWatch Express Gateway.

ENVIRONMENT

Operational temperature 0 to 50°C (32 to 122°F)
Storage temperature -20 to 60°C (-4 to 140°F)
Relative Humidity (RH) 5% to 95% (non-condensing)

Not outdoor rated—use only indoors or inside an outdoor rated enclosure

PROGRAMMING

MAIN SCREEN

The main screen gives the operator an overview of the lift station status including any active alarms.

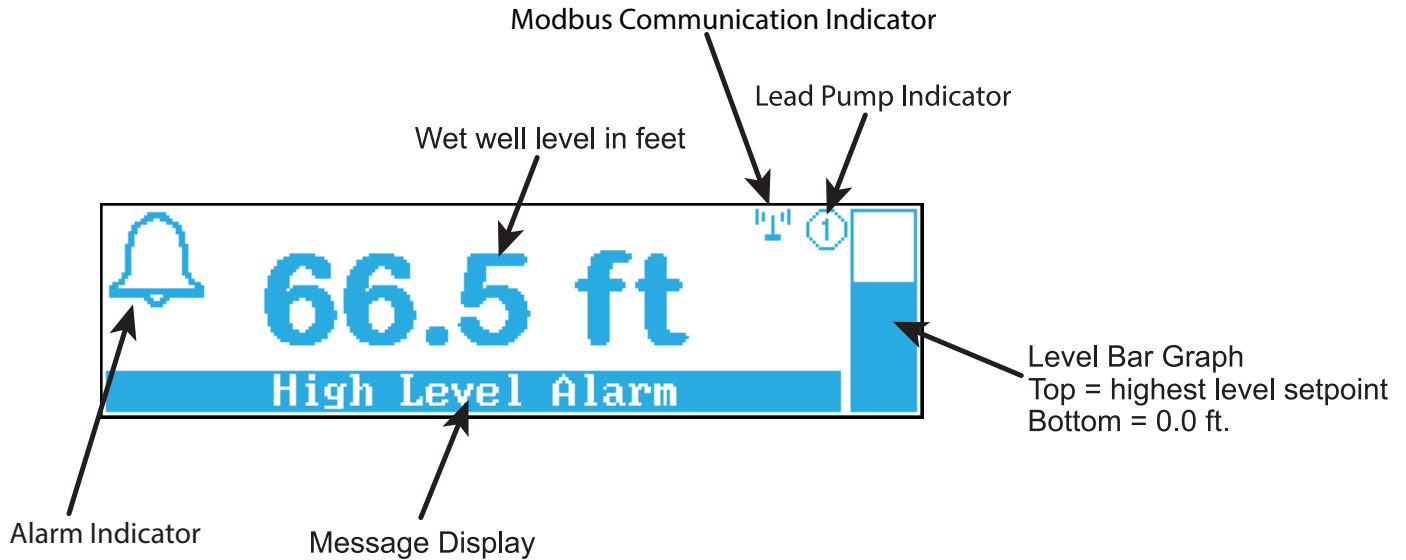

USER INTERFACE

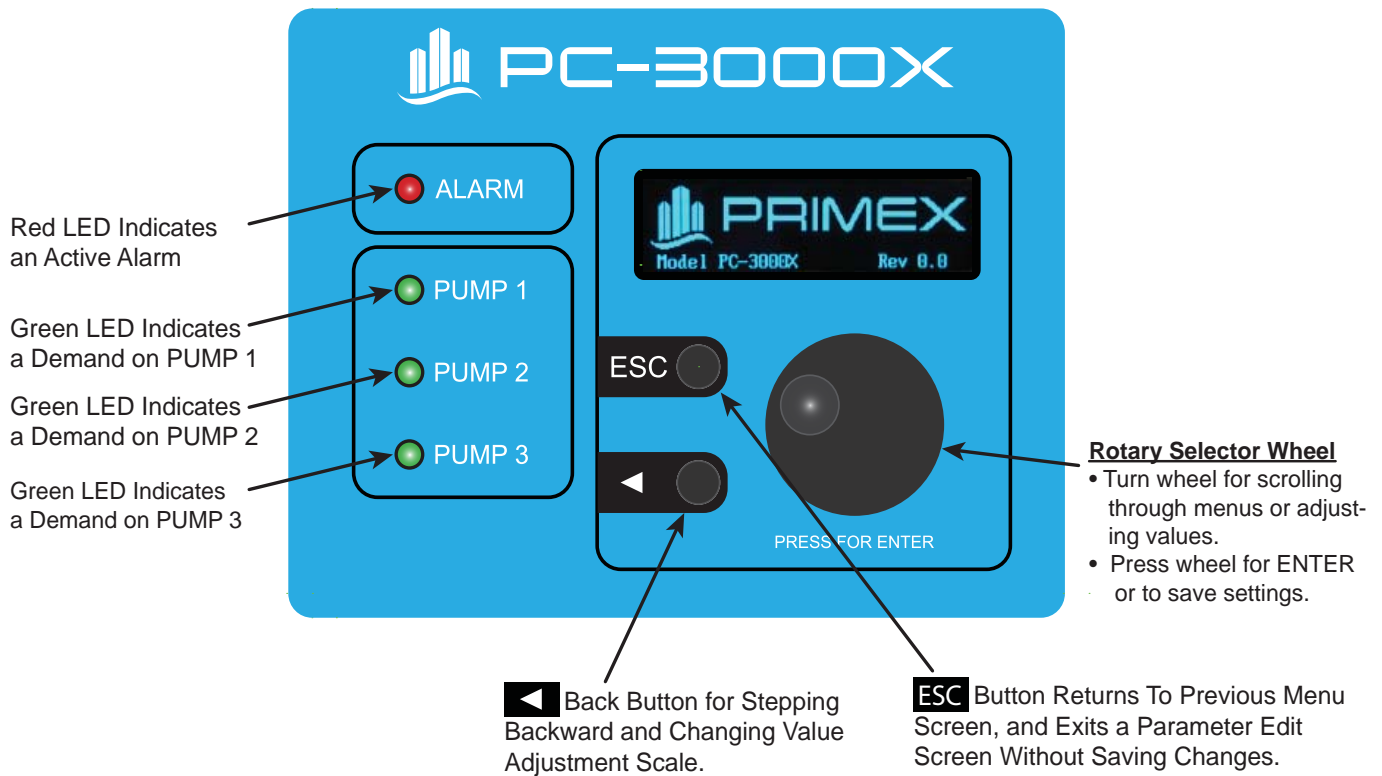

MAIN MENU

While in the Main Display screen, press the ENTER button to view the Main Menu.

— Main Menu —	
Alternation	
Level Setpoints	
Counts and ETMs	
Flow Measurements	
Level Simulation	Disabled
Advanced Settings	

ALTERNATION

— Edit Alternation —	
Alternate	
Pump 1 Lead	
Pump 2 Lead	
Pump 3 Lead	

LEVEL SETPOINTS

These are the Level Setpoints that can be adjusted.

↓ — Level Setpoints —	
Lead Pump ON	10.0 ft
Lead Pump OFF	6.0 ft
Lag Pump ON	11.0 ft
Lag Pump OFF	6.0 ft

↑ — Level Setpoints —	
Lag2 Pump ON	12.0 ft
Lag2 Pump OFF	6.0 ft
High Level Alarm	16.0 ft
Low Level Alarm	4.0 ft

An edit screen can be brought up by pressing the selector wheel when the desired setpoint is highlighted.

— Edit Lead Pump ON —	
010.0 ft	
Min: 0.1	Max: 20.0

To adjust the value simply scroll the wheel to the desired value and click the ENTER wheel to save the setting. The adjustment scale will default to tenths. The adjustment scale can be set to tenths, ones, tens and hundreds. Tenths is shown above. Depending on the specific adjustment, hundreds may not be an option.

To adjust the scale, click the ◀ button until the desired increment is highlighted.



Ones will be adjusted



Tens will be adjusted

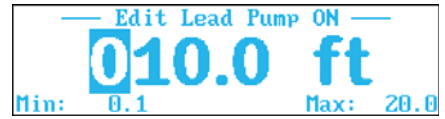

Hundreds will be adjusted

The default scale is feet. This can be changed using the advanced settings menu.

To ignore any changes and return to the previous screen, press the ESC button or press and hold the ◀ button.

COUNTS AND ETMS (ELAPSED TIME METERS)

The following three screens show the nine different Counts and ETMs that are tracked.

↓ — Counts and ETMS —	
Pump 1 ETM	0.00 HRS
Pump 2 ETM	0.00 HRS
Pump 3 ETM	0.00 HRS
Pump 1 Run Cycles	0

↑ — Counts and ETMS —	
Pump 3 ETM	0.00 HRS
Pump 1 Run Cycles	0
Pump 2 Run Cycles	0
Pump 3 Run Cycles	0

↑ — Counts and ETMS —	
Pump 3 Run Cycles	0
High Level Alarms	0
Low Level Alarms	0
Backup Float Closures	0

A CLEARING COUNT APPROVAL screen can be brought up by clicking the ENTER button when the desired count is highlighted. Pump ETMs cannot be cleared.

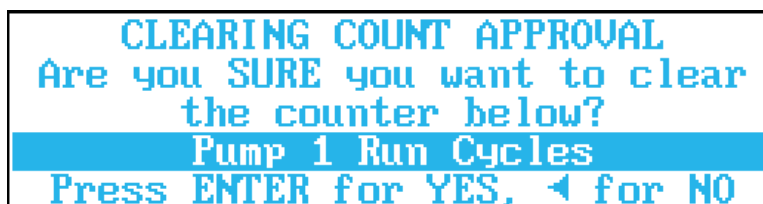

Following the onscreen directions, press ENTER for YES, ◀ for NO.

If ENTER is pressed the next screen will ask if you are sure you want to clear. If ENTER is pressed for YES here, the count is permanently cleared to zero, and this action cannot be reversed.

```
      WARNING!
Clearing the count is permanent
and cannot be reversed.
Are you SURE you want to clear?
Press ENTER for YES, ◀ for NO
```

If ◀ for NO is pressed you will be returned to the main Counts and ETMs screen.

FLOW MEASUREMENTS

The following screen shows the four flow rates that are calculated by the PC-3000X. The calculations are based on the Tank Diameter (see STATION DATA menu), and the tank fill time from Lead Pump Off level to Lead Pump On level (for Station Inflow) or tank discharge time from Lead Pump On level to Lead Pump Off level (for Pump GPM). The value shown is always for the most recently completed fill or discharge cycle.

```
      — Flow Measurements —
Station Inflow      999 GPM
Pump 1 Flow        999 GPM
Pump 2 Flow        999 GPM
Pump 3 Flow        999 GPM
```

LEVEL SIMULATION

When Enabled, **Level Simulation** is used to temporarily use the selector wheel to simulate input level changes. This can be helpful for troubleshooting a system to make sure the controller is functioning correctly without actually having various level scenarios available.

```
      — Edit Level Simulation —
                Disabled
                Enabled
```

```
      38.4 in ①
Simulate Mode (ESC to exit)
Hold down ◀ for coarse adj.
```

Rotate the selector wheel to make fine adjustments. To make coarse adjustments, press and hold the ◀ button while rotating the selector wheel.

ADVANCED SETTINGS

The Advanced Settings menu contains the following 18 settings.

— Advanced Settings —	
Transmitter Range	15.0 ft
Level Offset	0.0 ft
Number of Pumps	3
Pump ON Delay	5 sec
Pump OFF Delay	5 sec
Setpoint Dwell Time	2 sec
Backup Float Run Time	0 sec
Aux/Dis Input Function	Feedback
Starter Run Feedback Time	2 sec
Seal Fail Polarity	Normal
Temp Fail Reset Mode	Auto-Reset
Aux Relay Function	Horn
Mute/Rst/PwrFail Funct.	Mute/Rst
Max Pumps On At Once	3
Analog Out Low Level	0.0 ft
Analog Out High Level	15.0 ft
Level Units	Feet
Pumping Direction	Down
<input type="checkbox"/> I/O Status	
<input type="checkbox"/> Remote Fault Status	
<input type="checkbox"/> Station Data	

TRANSMITTER RANGE

Enter the full range of your level transmitter. For example, for a 0-20' WC transmitter, the Transmitter Range setting should be "020.0 ft". Allowable range: 1.0 to 999.9.

LEVEL OFFSET

Use the Level Offset if you want the displayed level to take into account space between the bottom of the level transducer and the bottom of the tank. If the level transducer was mounted one foot above the bottom of the tank, the Level Offset setting should be "001.0 ft". All level setpoints are referenced to the displayed level, which includes any Level Offset. Allowable range: 0.0 to (999.9 – Transmitter Range).

NUMBER OF PUMPS

Enter the number of pumps you are using. When set to '2', the controller operates as a duplex controller using pumps 1 and 2. When set to '1', the controller operates as a simplex controller using pump 1 only. Allowable Range: 1 to 3.

PUMP ON DELAY

This setting controls the minimum time allowed between one pump turn-on and the next pump turn-on. If set to zero, this will allow multiple pumps to turn on simultaneously. Note: the Pump ON Delay does not affect the first pump to turn on after power-up. Allowable range: 0 to 250 seconds.

PUMP OFF DELAY

This setting controls the minimum time allowed between one pump turn-off and the next pump turn-off. If set to zero, this will allow multiple pumps to turn off simultaneously. Note: the Pump OFF Delay does not affect the first pump to turn off after power-up. Allowable range: 0 to 250 seconds.

SETPOINT DWELL TIME

The controller provides a means of dealing with varying input levels around setpoints. The Setpoint Dwell Time is a minimum time a setpoint level must stay active before the setpoint is recognized. The interval can be set to a value from 0 to 99 seconds. A value of zero means the setpoint level will be instantly recognized. This feature can be very useful in water pressure systems where the pressure may rapidly vary for several seconds after a pump is turned off or on. In such a case, the SETPOINT DWELL TIME setting should be set longer than the pressure takes to settle so pumping will wait until the new pressure has stabilized. Allowable range: 0 to 99 seconds.

***Example:** assume the SETPOINT DWELL TIME setting is set to 8 seconds, and the LEAD setpoint is set to 10 inches. In a pump down system, if the level goes up and stays ≥ 10 inches, the controller will recognize the setpoint as active after 8 seconds have passed. If within 8 seconds the level drops below 10 inches, the level is not recognized and the dwell timer is reset.*

BACKUP FLOAT RUN TIME

Set this value to the amount of time the pump(s) should continue to run after the backup float tips back down. Setting this to 0 seconds will disable the float backup pump run feature, while still allowing the float backup high level alarm feature to work. Allowable range: 0 to 999 seconds.

AUX/DIS INPUT FUNCTION

The Aux/Dis inputs can be set to function one of two ways:

Starter Run Feedback – The Aux/Dis input for each pump is feedback from the motor contactor or other device (flow switch, current sensor, etc.) confirming that that pump did start when it was called. From the time a pump is called to run, the Aux/Dis input for the corresponding pump must close (short to COM) within the amount of time defined in Starter Run Feedback Time, or else the Pump Fail To Start fault will be activated.

Pump Disable – The Aux/Dis input for each pump is a “pump disable” input, preventing the corresponding pump from being called to run any time the input is closed (shorted to COM).

STARTER RUN FEEDBACK TIME

When the Aux/Dis Input Function setting is set to “Starter Run Feedback”, this setting controls how long the controller will wait after a pump is called to run for the corresponding Aux/Dis input to close. If the Aux/Dis Input Function setting is set to “Pump Disable”, this setting has no effect. Allowable Range: 1 to 99 seconds.

SEAL FAIL POLARITY

By default, the Seal Fail Polarity is set to Normal, which means that the seal fail fault trips when the resistance in the seal probe drops below 50k Ω . When Seal Fail Polarity is set to Inverted, the seal fail fault trips when the resistance in the seal probe increased above 75k Ω .

Note: if using a single-wire seal probe, the probe should be wired to the seal leak input terminal; no connection of the seal probe to the COM terminal is necessary if the controller is properly grounded.

TEMP FAIL RESET MODE

By default the Temp Fail Reset Mode is set to Auto-Reset. After a pump overtemp sensor trips, the contacts will re-close after a cooldown. In Auto-Reset mode, a pump will be available to be called when this happens. When Temp Fail Reset Mode is set to Latched, the pump will not be returned to service until manually reset by an operator by pressing the ESC pushbutton or externally using the MUTE/RESET input.

AUX RELAY FUNCTION

The Aux/Horn relay output can operate in one of several different modes:

Horn – This setting is intended to be used with an audible alarm. The relay will close on a high level alarm, low level alarm, or high level float fault. If an operator uses an external pushbutton on the MUTE/RESET input (or if the alarm condition goes away), this relay will open.

Seal – The relay will close if there is a seal fail condition on any pump.

Temp – The relay will close if there is a temperature fail condition on any pump.

Temp-Seal – The relay will close if there is a seal fail or temperature fail condition on any pump.

All – The relay will close if there is a high level alarm, low level alarm, high level float alarm, or seal fail or temperature fail condition on any pump.

MUTE/RESET/POWERFAIL FUNCTION

To use the Mute/Reset digital input (terminal J3-9) as an input for a Mute (also known as Silence) pushbutton, set Mute/Reset/PowerFail Function to “Mute/Reset Pushbutton”. To instead use that digital input as an indication of a mains power failure (when using a 24VDC backup battery to power the PC-3000X), use the “Power Fail Detection” setting. A power failure condition is detected whenever that input is closed. When a power fail occurs, an alarm message will be shown on the main screen immediately. If you are using Modbus communication for a telemetry device such as the PRIMEX PumpWatch, the power fail fault indication Modbus bit will be delayed by the number of seconds indicated in the Power Fail Delay Time setting. This allows the system to recover from very brief power outages without remote alarm notification.

MAX PUMPS ON AT ONCE

Typically, the Max Pumps On At Once will be set the same as Number Of Pumps. However, if for reasons of limiting the maximum current or maximum flow, the number of pumps running at the same time needs to be limited, this setting can be lowered.

ANALOG OUT LOW LEVEL

This setting defines the displayed level reading that corresponds with 4.0 mA on the analog output. This can be set below or above the Analog Out High Level setting.

ANALOG OUT HIGH LEVEL

This setting defines the displayed level reading that corresponds with 20.0 mA on the analog output. This can be set above or below the Analog Out Low Level setting.

Example: If you want the 4-20 mA output to be scaled such that it outputs 4mA at a 5.0-ft level reading, and 20 mA at a 10.0-ft level reading, you would set the Analog Out Low Level setting to 5.0 ft, and the Analog Out High Level setting to 10.0 ft.

LEVEL UNITS

This setting defines what units label is applied to the level input reading and all level settings. The available settings are: inches, feet, meters, centimeters, PSI, kPa, and bar.

PUMPING DIRECTION

While most applications of the PC-3000X are for a pump-down system, it can also be used in pump-up applications. Because this represents such a major shift in how the controller operates, when changing from one pumping direction to the other, all other user settings are set to default values. To prevent this from occurring accidentally, changing the pumping direction requires progressing through two confirmation screens.

Note: If for some reason the user wishes to restore all settings to factory defaults, this can be done by changing the Pumping Direction, then changing it back again.

STATION DATA

This information is not used in any control or alarm functions, and is simply for the user's future reference. The pump's horsepower, voltage, and FLA, as well as the tank diameter and height of the tank inlet, can be entered here and referred to at a later date.

— Station Data —	
Pump Horsepower	999
Pump Voltage	999
Pump FLA	999.9 FLA
Tank Diameter	999.9 ft
Inlet Height	999.9 ft

REMOTE FAULT STATUS

The Remote Fault Status menu contains the following two settings.

— Remote Fault Status —	
Power Fail Delay Time	20 sec
Max. Pump Run Time	0.0 hr

POWER FAIL DELAY TIME

This setting controls the number of seconds of delay after a power failure is detected (on input J3-9) until the Power Fail fault is indicated via Modbus. Allowable range: 0 to 999 seconds.

MAX. PUMP RUN TIME

If any pump runs continuously for the amount of time specified by this setting, the Max Run Time fault is indicated via Modbus. Note: this fault will not turn off the pump or otherwise affect the running of the pump(s); it is for Modbus notification only. Turn off this feature by setting Max. Pump Run Time to 0. Allowable range: 0 to 99.9 hours.

I/O STATUS SCREENS

— I/O Status —	
☐ Digital Input Status	
☐ Relay Output Status	
☐ Analog I/O Status	

DIGITAL INPUT STATUS

— Digital Input Status —				
	Temp	Seal	Aux	Mute
Pump 1	Clsd	Open	Open	Open
Pump 2	Clsd	Open	Open	Hi Float
Pump 3	Clsd	Open	Open	Open

This screen shows the status of all eleven digital (discrete) inputs. Each input is shown as either open circuit (“Open”) or closed circuit, meaning shorted to COM (“Clsd”). This can be used for troubleshooting to make sure the controller is seeing changes in input states.

RELAY OUTPUT STATUS

— Relay Output Status —			
Pump 1	On	High Alarm	Off
Pump 2	Off	Low Alarm	Off
Pump 3	Off	Horn/Aux	Off

This screen shows the status of all six relay outputs. Each relay output is shown as either open circuit (“Off”) or closed circuit (“On”). This can be used for troubleshooting to make sure the controller is turning on and off the output relays you expect it to.

ANALOG I/O STATUS

— Analog I/O Status —	
AI Level	A Out
14.39 mA	09.14 mA

This screen shows the current in mA of the analog input (AI LEVEL) and analog output (AOUT). This can be used for troubleshooting to make sure the 4-20 mA signals are behaving as expected.

OPERATION

PUMP DOWN OPERATION

Pump down control is used in applications like wastewater lift stations, where a liquid flows into a tank and must be pumped out. A level transmitter sends the present level to the controller where it is continually monitored and displayed.

Pump Down Operation with Number of Pumps = 1

When Number of Pumps = 1, the only pump controlled will be Pump 1, and the Lead Pump ON/OFF setpoints are used. When the level rises above the Lead Pump ON Setpoint, the pump will be called to run; when the level drops below the Lead Pump OFF Setpoint, the pump will be turned off.

Pump Down Operation with Number of Pumps = 2

When Number of Pumps = 2, the Lead pump will initially be Pump 1 and the Lag pump will be Pump 2.

Pump Operation when Sequence = Pump 1 Lead or Pump 2 Lead

When the level rises above the Lead Pump ON Setpoint, the Lead pump will be called to run; when the level drops below the Lead Pump OFF Setpoint, the Lead pump will be turned off. If the level rises to the Lag Pump ON setpoint, the Lag pump will run; when the level drops below the Lag Pump OFF Setpoint, the Lag pump will be turned off.

Pump Operation when Sequence = Alternate

Pumping works the same as mentioned in the previous paragraph, except when any pumps were running and all have turned off, the pump assignment will alternate as follows:

Current Pump Assignment		Next Pump Assignment	
Lead	Lag	Lead	Lag
Pump 1	Pump 2	Pump 2	Pump 1
Pump 2	Pump 1	Pump 1	Pump 2

Pump Down with Number of Pumps = 3

When Number of Pumps = 3, the Lead pump will initially be Pump 1, the Lag pump will initially be Pump 2, and the Lag2 pump will initially be Pump 3.

Pump Operation When Sequence = Pump X Lead

When the level rises above the Lead Pump ON Setpoint, the Lead pump will be called to run; when the level drops below the Lead Pump OFF Setpoint, the Lead pump will be turned off. If the level rises to the Lag Pump ON setpoint, the Lag pump will run; when the level drops below the Lag Pump OFF Setpoint, the Lag pump will be turned off. If the level rises to the Lag2 Pump ON setpoint, the Lag2 pump will run; when the level drops below the Lag2 Pump OFF Setpoint, the Lag2 pump will be turned off.

Pump Operation When Sequence = Alternate

Pumping works the same as mentioned in Pump X Lead above, except when any pumps were running and all have turned off, the pump assignment will alternate as follows:

Current Pump Assignment			Next Pump Assignment		
Lead	Lag	Lag2	Lead	Lag	Lag2
Pump 1	Pump 2	Pump 3	Pump 2	Pump 3	Pump 1
Pump 2	Pump 3	Pump 1	Pump 3	Pump 1	Pump 2
Pump 3	Pump 1	Pump 2	Pump 1	Pump 2	Pump 3

Pump Down Single-Float Backup System

In pump-down applications, a single-float Backup System is available to provide a redundant means of pumping. If the level transmitter fails, the backup system can provide pump control to prevent potential problems. A normally-open float switch is positioned in the tank to close at levels above normal pumping levels, and is connected to the HIGH FLOAT input. If the level rises above the backup float switch position, the Backup System will activate. The Backup System is enabled when the BACKUP FLOAT RUN TIME setting is a non-zero value.

If the Backup System float closes, and backup is enabled, and the controller is not already calling for all available pumps then the backup mode is initiated and the lead pump is called to run. If the level drops below the Backup System float position, the lead pump will continue to pump for the BACKUP FLOAT RUN TIME interval. If the level does not drop below the Backup System float position within 30 seconds of the lead pump turning on, and the system has more than one pump available, the lag pump will then also turn on; if the level does not drop within 60 seconds of the lead pump turning on, and the system has more than two pumps available, the Lag2 pump will then also turn on. If either

of the lag pumps runs and the level drops below the Backup System float position, each of the lag pumps will respectively pump for the BACKUP FLOAT RUN TIME interval from when the float switch opened before turning off. Activation of the Backup System will be indicated on the display and remain until cleared by the ESC button or the external reset/mute button.

This single-float backup provides a backup for a level transmitter failure only. It is integral to the PC-3000X controller, and does not provide backup operation in the event of total controller failure. A separate backup alarm float should always be used.

PUMP UP OPERATION

Pump up control is used in applications like water distribution, where pressure must be controlled in a fill tank (e.g. a water tower). In such an application, the level is sensed by a pressure transmitter mounted in the base of the tank. The controller operates pumps to raise the level (and therefore pressure) in the tank. Simply viewed, pump-up control is like pump-down control but the setpoints are inverted.

Pump Up Operation with Number of Pumps = 1

When Number of Pumps = 1, the only pump controlled will be Pump 1, and the Lead Pump ON/OFF setpoints are used. When the level drops below the Lead Pump ON Setpoint, the pump will be called to run; when the level rises above the Lead Pump OFF Setpoint, the pump will be turned off.

Pump Up Operation with Number of Pumps = 2

When Number of Pumps = 2, the Lead pump will initially be Pump 1 and the Lag pump will be Pump 2.

Pump Operation when Sequence = Pump X Lead

When the level drops below the Lead Pump ON Setpoint, the Lead pump will be called to run; when the level rises above the Lead Pump OFF Setpoint, the Lead pump will be turned off. If the level drops to the Lag Pump ON setpoint, the Lag pump will run; when the level rises above the Lag Pump OFF Setpoint, the Lag pump will be turned off.

Pump Operation when Sequence = Alternate

Pumping works the same as mentioned in Pump X Lead above, except when any pumps were running and all have turned off, the pump assignment will alternate as follows:

Current Pump Assignment		Next Pump Assignment	
Lead	Lag	Lead	Lag
Pump 1	Pump 2	Pump 2	Pump 1
Pump 2	Pump 1	Pump 1	Pump 2

Pump Up with Number of Pumps = 3

When Number of Pumps = 3, the Lead pump will initially be Pump 1, the Lag pump will initially be Pump 2, and the Lag2 pump will initially be Pump 3.

Pump Operation When Sequence = Pump X Lead

When the level drops below the Lead Pump ON Setpoint, the Lead pump will be called to run; when the level rises above the Lead Pump OFF Setpoint, the Lead pump will be turned off. If

the level drops to the Lag Pump ON setpoint, the Lag pump will run; when the level rises above the Lag Pump OFF Setpoint, the Lag pump will be turned off. If the level drops to the Lag2 Pump ON setpoint, the Lag2 pump will run; when the level rises above the Lag2 Pump OFF Setpoint, the Lag2 pump will be turned off.

Pump Operation When Sequence = Alternate

Pumping works the same as mentioned in Pump X Lead above, except when any pumps were running and all have turned off, the pump assignment will alternate as follows:

Current Pump Assignment			Next Pump Assignment		
Lead	Lag	Lag2	Lead	Lag	Lag2
Pump 1	Pump 2	Pump 3	Pump 2	Pump 3	Pump 1
Pump 2	Pump 3	Pump 1	Pump 3	Pump 1	Pump 2
Pump 3	Pump 1	Pump 2	Pump 1	Pump 2	Pump 3

Level Alarms

When the level is equal to or below the Low Level Alarm Setpoint, a low alarm condition will be activated and will remain active until cleared (see below). When a low alarm is active, the low alarm relay contacts will be closed, and the horn relay contacts will be closed (if AUX RELAY FUNCTION = HORN or ALL). A low alarm condition is cleared when the level rises above the Low Level Alarm Setpoint.

When the level is equal to or above the High Level Alarm Setpoint, a high alarm condition will be activated and will remain active until cleared (see below). When a high alarm is active, the high alarm relay contacts will be closed, and the horn relay contacts will be closed (if AUX RELAY FUNCTION = HORN or ALL). A high alarm condition is cleared when the level is below the High Level Alarm Setpoint.

Pump On/Off Delay Timers

The controller provides a means of preventing one or more pumps from starting or stopping at the same time. The PUMP ON DELAY setting is an interval to wait after a pump turns on before allowing another pump to turn on. The PUMP OFF DELAY setting is an interval to wait after a pump turns off before allowing another to turn off. The PUMP ON DELAY and the PUMP OFF DELAY settings can be set to a value from 0 to 250 seconds. A PUMP ON DELAY setting of zero will allow pumps to turn on simultaneously; a PUMP OFF DELAY setting of zero will allow pumps to turn off simultaneously.

Pump Start Failure Detection and External Disable Inputs

The controller provides inputs to detect pump failure-to-start conditions and the same inputs can be used to externally disable pumps.

Pump Start Failure Detection Inputs

To use the inputs as start failure detection inputs, the AUX/DIS INPUT FUNCTION setting must be set to STARTER FEEDBACK. The controller monitors the Aux/Disable input to detect a pump failure to start condition. A fault is detected if a contact closure from the input to ground is not made within the startup detect interval. The STARTUP DETECT INTERVAL setting can be set from 1 to 99 seconds. For example, say STARTUP DETECT INTERVAL is set to 15 seconds and a pump is called to start. If the Aux/Disable input for that pump is not connected to ground within 15 seconds, a pump failure to start will be reported.

The failure will be reported on the display until reset by an operator by pressing the ESC push-button or externally using the MUTE/RESET input. When a pump failure occurs, a message will be reported, the horn relay contacts will be closed (if Horn = ENABLED) and the pump will be removed from service.

External Disable Inputs

To use the inputs as pump disable inputs, the AUX/DIS INPUT FUNCTION setting must be set to PUMP DISABLE. The controller monitors the Aux/Disable input to detect a contact closure to ground. A pump will be disabled if the Aux/Disable input shows a connection to ground.

Setpoint Dwell Time

The controller provides a means of dealing with varying input levels around setpoints. The Setpoint Dwell Time is a minimum time a setpoint level must stay active before the setpoint is recognized. The interval can be set to a value from 0 to 99 seconds. A value of zero means the setpoint level will be instantly recognized. This feature can be very useful in water pressure systems where the pressure may rapidly vary for several seconds after a pump is turned off or on. In such a case, the SETPOINT DWELL TIME setting should be set longer than the pressure takes to settle so pumping will wait until the new pressure has stabilized

As an example, assume the SETPOINT DWELL TIME setting is set to 8 seconds, and the LEAD setpoint is set to 10 inches. In a pump down system, if the level goes up and stays ≥ 10 inches, the controller will recognize the setpoint as active after 8 seconds have passed. If within 8 seconds the level drops below 10 inches, the level is not recognized and the dwell timer is reset.

Pump Runtime Limiter

When the Alternation mode is set to "Alternate", if a pump runs for 24 hours continuously, the alternator will advance to the next lead pump, turning off the currently running lead pump and starting the next pump as the new lead pump. This 24 hour period cannot be adjusted by the user.

ALARMS

ALARM TEXT	DEFINITION	FIX
HIGH LEVEL ALARM	The level is at or above the High Level setpoint	Check pump operation, check in-flow, check level transducer
HIGH LEVEL FLOAT	The high level (backup) float is closed	Check pump operation, check in-flow, check level transducer
HIGH LEVEL FLOAT (LATCHED)	The high level (backup) float had closed in the past, but is now open	Press ESC to reset, check pump operation, check in-flow, check level transducer
LOW LEVEL ALARM	The level is at or below the Low Level setpoint	Check wet well, check level transducer
PUMP 1 DISABLED	The Pump 1 Disable input is closed	Open the Pump 1 Disable input
PUMP 1 FAILED TO START	Pump 1 was called to run but the Pump 1 Aux input did not close within the user-specified time	Press ESC to reset, check pump operation, check overload trip

ALARMS

ALARM TEXT	DEFINITION	FIX
PUMP 1 SEAL FAIL	The Pump 1 seal probe input resistance to ground has dropped below 50kΩ (or above 75kΩ if Seal Fail Polarity is set to INVERTED)	Check pump seal
PUMP 1 TEMP FAIL	The Pump 1 temp input is open	Check voltage, pump clogging, or wear
PUMP 1 TEMP FAIL (LATCHED)	The Pump 1 temp input had opened in the past, but is now closed again	Press ESC to reset, check voltage, pump clogging, or wear
PUMP 2 DISABLED	The Pump 2 Disable input is closed	Open the Pump 2 Disable input
PUMP 2 FAILED TO START	Pump 2 was called to run but the Pump 2 Aux input did not close within the user-specified time	Press ESC to reset, check pump operation, check overload trip
PUMP 2 SEAL FAIL	The Pump 2 seal probe input resistance to ground has dropped below 50kΩ (or above 75kΩ if Seal Fail Polarity is set to INVERTED)	Check pump seal
PUMP 2 TEMP FAIL	The Pump 2 temp input is open	Check voltage, pump clogging, or wear
PUMP 2 TEMP FAIL (LATCHED)	The Pump 2 temp input had opened in the past, but is now closed again	Press ESC to reset, check voltage, pump clogging, or wear
PUMP 3 DISABLED	The Pump 3 Disable input is closed	Open the Pump 3 Disable input
PUMP 3 FAILED TO START	Pump 3 was called to run but the Pump 3 Aux input did not close within the user-specified time	Press ESC to reset, check pump operation, check overload trip
PUMP 3 SEAL FAIL	The Pump 3 seal probe input resistance to ground has dropped below 50kΩ (or above 75kΩ if Seal Fail Polarity is set to INVERTED)	Check pump seal
PUMP 3 TEMP FAIL	The Pump 3 temp input is open	Check voltage, pump clogging, or wear
PUMP 3 TEMP FAIL (LATCHED)	The Pump 3 temp input had opened in the past, but is now closed again	Press ESC to reset, check voltage, pump clogging, or wear
TRANSDUCER SHORT CIRCUIT	The 4-20mA level input signal is greater than 20.25 mA	Check level transducer operation, wiring, and vent tube.
TRANSDUCER OPEN CIRCUIT	The 4-20mA level input signal is less than 3.75 mA	Check level transducer operation, wiring, and vent tube.
POWER FAILURE DETECTED	The Mute/Reset/PowerFail Function setting is set to "Power Fail", and the Power Failure input (J3-9) is closed.	Verify proper control panel incoming voltage, and check for tripped breakers or blown fuses.

PC-3000X POWER UP SCREEN (VERSION)

On power up, the screen will display the version of the program. Always have the version number ready when contacting the factory for service.



I/O TERMINAL CONFIGURATION

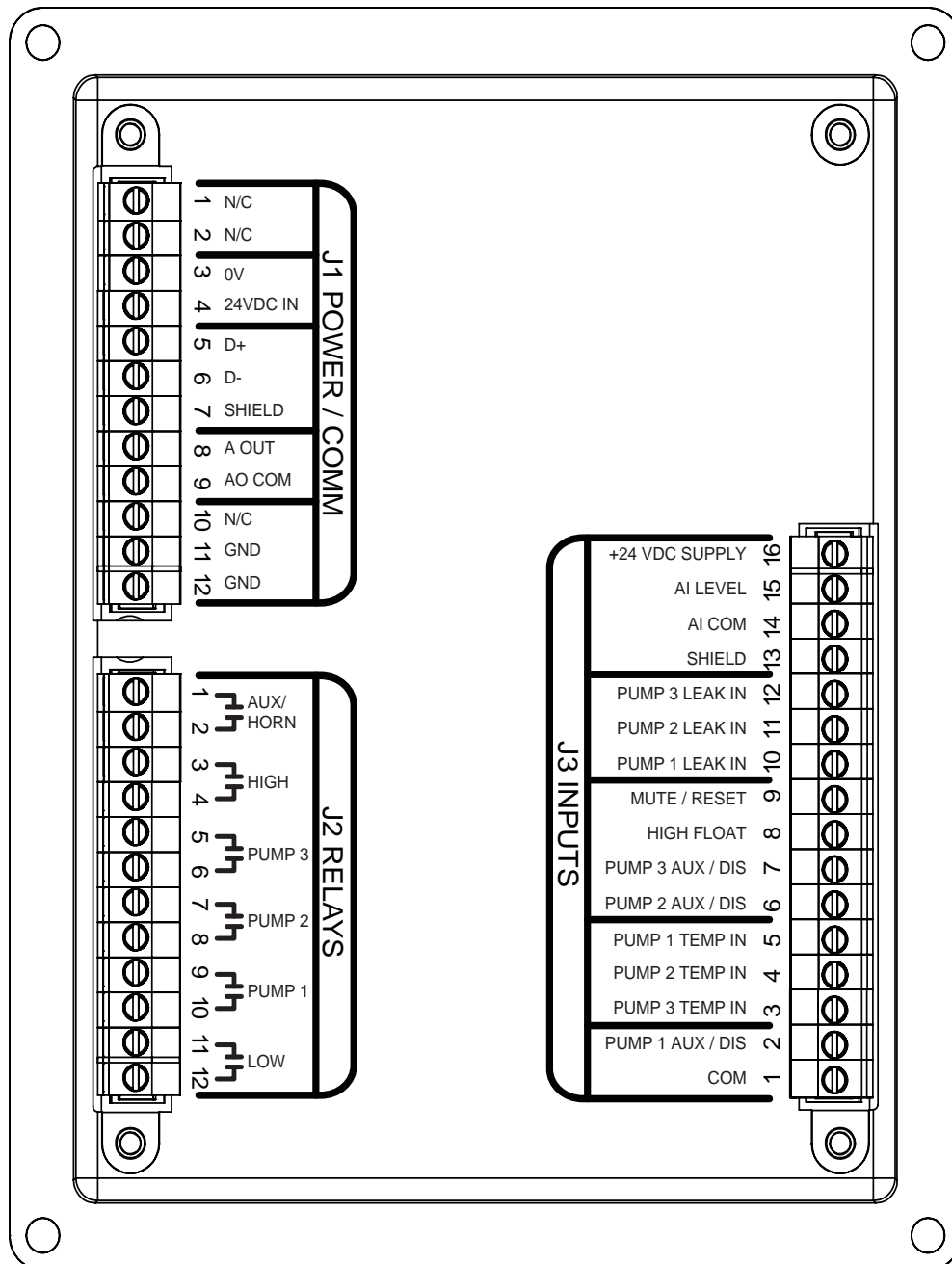

PC-3000X I/O TABLE

J1 POWER AND COMMUNICATIONS		
PIN	NAME	DESCRIPTION
1	N/C	- NO CONNECTION -
2	N/C	- NO CONNECTION -
3	0V	RETURN FOR +24 VDC SUPPLY
4	+24 VDC	19 - 28 VDC SUPPLY
5	D+	MODBUS (RS-485 NON-INVERTING)
6	D-	MODBUS (RS-485 INVERTING)
7	SHIELD	
8	A OUT	4-20mA LOOP, POWER SUPPLIED
9	AO COM	4-20mA LOOP RETURN
10	N/C	- NO CONNECTION -
11	GND	PROTECTIVE EARTH GROUND
12	GND	PROTECTIVE EARTH GROUND

J2 RELAY OUTPUTS		
PIN	NAME	DESCRIPTION
1	AUX / HORN	AUX/HORN RELAY CONTACTS
2		
3	HIGH	HIGH ALARM RELAY CONTACTS
4		
5	PUMP 3	PUMP 3 RELAY CONTACTS
6		
7	PUMP 2	PUMP 2 RELAY CONTACTS
8		
9	PUMP 1	PUMP 1 RELAY CONTACTS
10		
11	LOW	LOW ALARM RELAY CONTACTS
12		

J3 DIGITAL INPUTS		
PIN	NAME	DESCRIPTION
1	COM	INPUT COMMON RETURN
2	PUMP 1 AUX / DIS	PUMP 1 AUX/DISABLE INPUT
3	PUMP 3 TEMP IN	PUMP 3 TEMP SENSOR INPUT
4	PUMP 2 TEMP IN	PUMP 2 TEMP SENSOR INPUT
5	PUMP 1 TEMP IN	PUMP 1 TEMP SENSOR INPUT
6	PUMP 2 AUX / DIS	PUMP 2 AUX/DISABLE INPUT
7	PUMP 3 AUX / DIS	PUMP 3 AUX/DISABLE INPUT
8	HIGH FLOAT	HIGH ALARM FLOAT INPUT
9	MUTE / RESET	MUTE/RESET INPUT
10	PUMP 1 LEAK IN	PUMP 1 LEAK SENSOR INPUT
11	PUMP 2 LEAK IN	PUMP 2 LEAK SENSOR INPUT
12	PUMP 3 LEAK IN	PUMP 3 LEAK SENSOR INPUT
13	SHIELD	
14	AI COM	4 - 20 mA LOOP RETURN
15	AI LEVEL	4 - 20 mA LOOP INPUT
16	+24 VDC OUT	LEVEL TRANSMITTER SUPPLY

Note:

Pins J1-3, J1-7, J1-11, J1-12, J3-1, J3-13 and J3-14 are all internally connected, and should be wired to Protective Earth Ground at terminal J1-11 or J1-12.

MODBUS COMMUNICATION

The PC-3000X is equipped with Modbus RTU support using the D+ and D- RS-485 terminals. The Modbus registers and communications specifications are designed work with a PRIMEX PumpWatch Express Gateway right out of the box.

- Baud Rate: 9600 baud
- Data Bits: 8 bits
- Stop Bits: 1 bit
- Parity: None
- Node Address: 1
- Modbus Function Codes Supported:
 - Read Holding Registers (0x03)
 - Write Single Register (0x06)
 - Write Multiple Registers (0x10)

Anytime the PC-3000X receives a valid Modbus request, a “Modbus Communication Active” icon () will appear on the Main Screen for 60 seconds. So if the Modbus master device is sending a Modbus request more often than once every 60 seconds, the icon will effectively be displayed continuously.

To connect the PC-3000X and the PumpWatch Express Gateway, follow the connection diagram below.

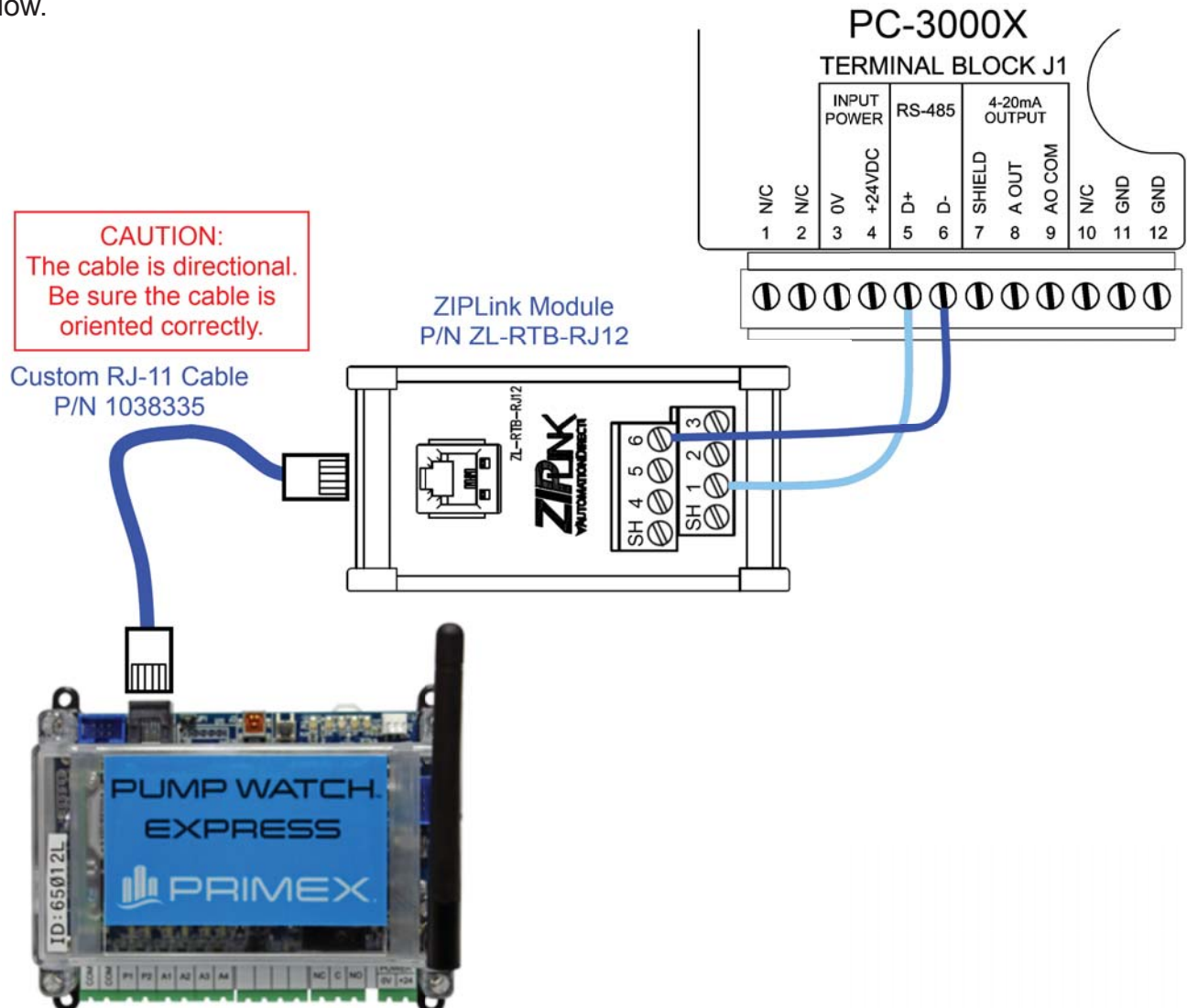

The following is a list of all accessible Modbus registers.

Access Type	Holding Register Number	Holding Register Address	Bit	Description	Unit of Measure (Other Notes)
Read/Write	2001	42002		Pump Data - HP	
Read/Write	2002	42003		Pump Data - Voltage	
Read/Write	2003	42004		Pump Data - FLA	Tenths of Amps
Read	2004	42005		Station In-flow	GPM (*)
Read	2005	42006		Level	Tenths of Feet
Read	2006	42007		--not used--	
Read	2007	42008		--not used--	
Read	2008	42009		--not used--	
Read	2009	42010		--not used--	
Read	2010	42011		Pump 1 GPM	GPM (*)
Read	2011	42012		Pump 2 GPM	GPM (*)
Read	2012	42013		Pump 3 GPM	GPM (*)
Read	2013	42014		--not used--	
Read	2014	42015		Pump1 Starts/24hrs	(**)
Read	2015	42016		Pump2 Starts/24hrs	(**)
Read	2016	42017		Pump3 Starts/24hrs	(**)
Read	2017	42018		--not used--	
Read	2018	42019		Pump 1 Run Time Per 24 hrs	Minutes (**)
Read	2019	42020		Pump 2 Run Time Per 24 hrs	Minutes (**)
Read	2020	42021		Pump 3 Run Time Per 24 hrs	Minutes (**)
Read	2021	42022		--not used--	
Read	2022	42023		Station Inflow Per 24 hrs	Hundreds of Gallons (**)
Read	2023	42024	0	Pump 1 Running	
			1	Pump 1 Fault	
			2	Pump 1 Auto	(Not Disabled = 1, Pump Disabled = 0)
			3	Pump 2 Running	
			4	Pump 2 Fault	
			5	Pump 2 Auto	(Not Disabled = 1, Pump Disabled = 0)
			6	Pump 3 Running	
			7	Pump 3 Fault	
			8	Pump 3 Auto	(Not Disabled = 1, Pump Disabled = 0)
			9-15	--not used--	
Read	2024	42025	0	--not used--	
			1	Power Fail	
			2	--not used--	
			3	High Level Alarm (Transmitter)	
			4-9	--not used--	
			10	High Level Alarm (Float)	
			11	Low Level Alarm	
			12	Pump Run Time Fault	
			13-15	--not used--	
Read	2025	42026		--not used--	
Read	2026	42027		--not used--	
Read	2027	42028	0	Pump 1 Seal Fail	
			1	Pump 2 Seal Fail	
			2	Pump 3 Seal Fail	
			3-15	--not used--	

* Holding Register numbers 2010 through 2012 hold the calculated GPM of each pump for that pump's last completed pumping cycle as the lead pump. Likewise, Holding Register 2004 holds the calculated GPM of the station inflow for the most recently completed fill cycle.

** Holding Register numbers 2014 through 2022 hold totals for the most recently completed 24-hour period. A 24-hour period begins at power-on, and ends 24 hours later, at which time the next 24-hour period begins. (When powering off, PC-3000X saves to memory where it was in the 24-hour timing cycle, and then when powered up, the timing picks back up where it left off.)

MOUNTING DIMENSIONS

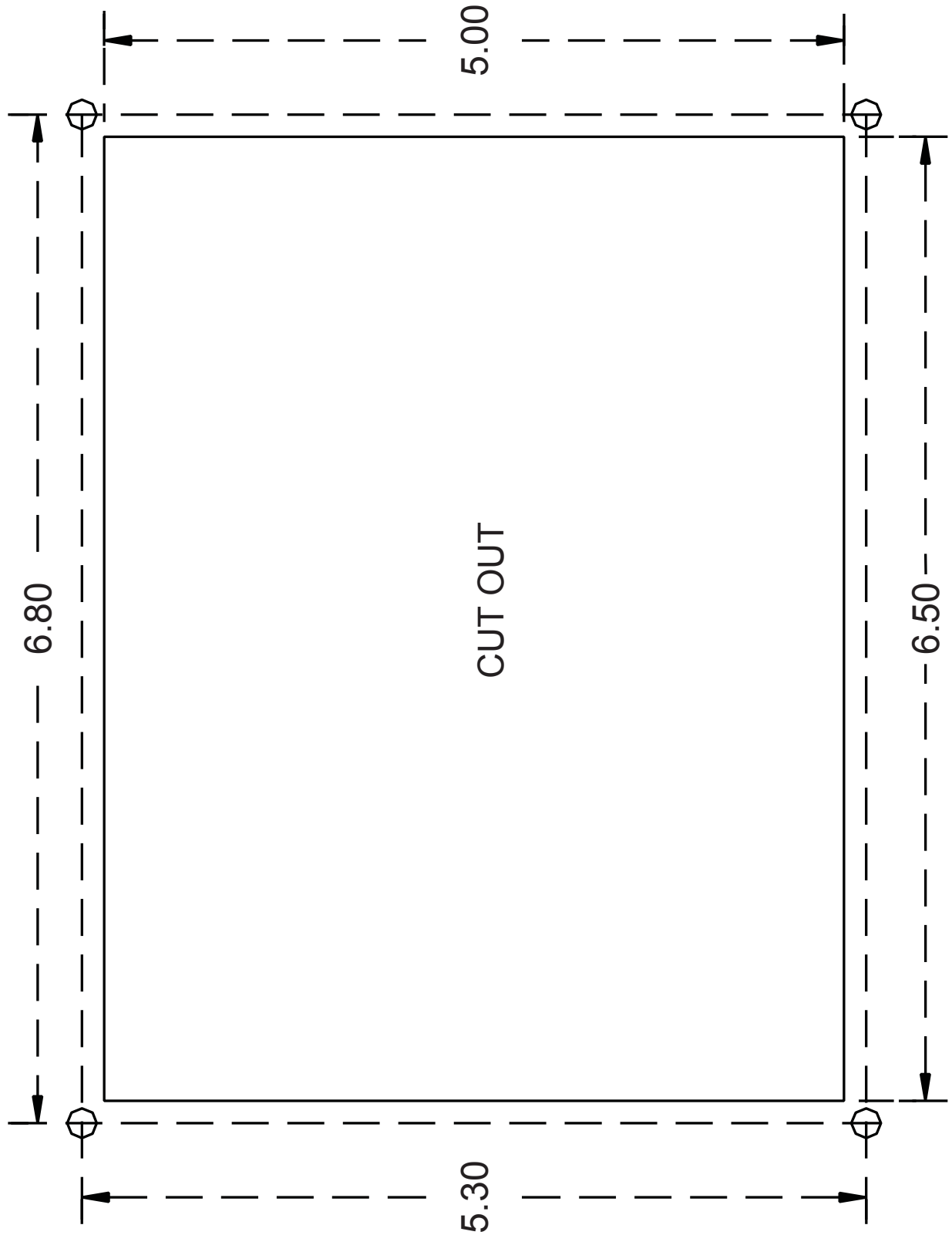

Not to scale. Do not use as a template.

CONTROLLER DIMENSIONS

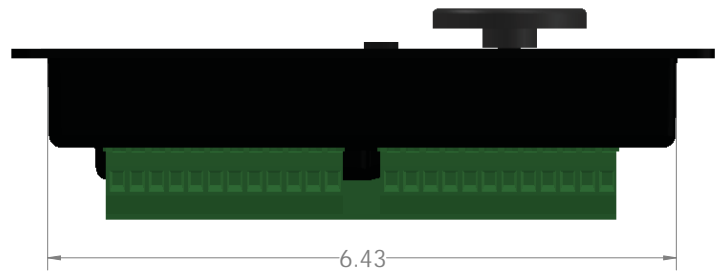
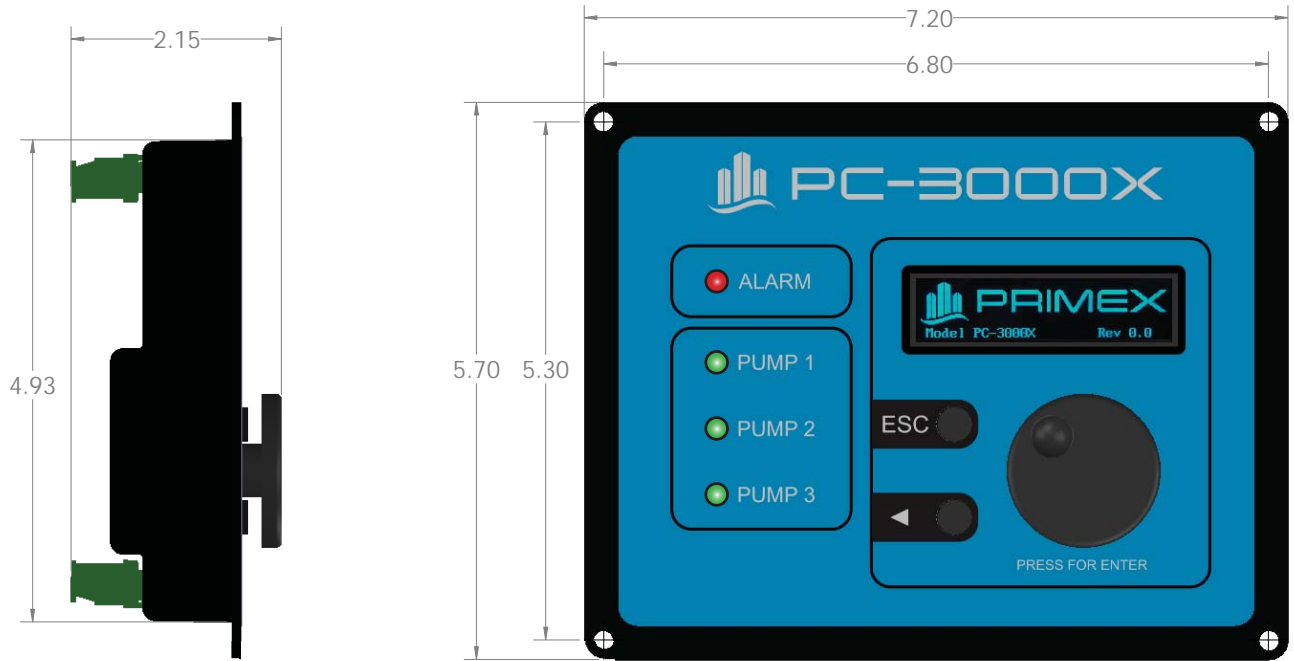

RETROFIT REPLACEMENT OF A PC-3000

The PC-3000X can be installed in place of a previously installed legacy PRIMEX PC-3000 controller. The steps to follow to do this are:

1. Carefully note all user settings on the PC-3000 before removal so the same settings can be entered on the PC-3000X after installation.
2. Switch off all power sources to the PC-3000 controller.
3. Unplug the three green pluggable terminal blocks from the back of the PC-3000. Carefully note which 12-position terminal block is plugged into which socket on the PC-3000 (J1 on the left, J2 on the right); you will need to be sure to plug them back in on the same locations on the PC-3000X.
4. Remove the four corner mounting screws that secure the PC-3000 housing to the subdoor.
5. Remove the PC-3000 from the subdoor cutout, and insert the PC-3000X in its place.
6. Secure the PC-3000X housing to the subdoor using the four corner screws you previously had removed from the PC-3000.
7. Plug the three green pluggable terminal blocks into the PC-3000X controller. Be sure the two 12-position terminal blocks are plugged into the correct locations, as noted earlier.
8. If the control panel does not already contain a Class 2 24VDC power supply, install one in the control panel. Connect the power supply's 0VDC signal to terminal J1-3, and the +24VDC signal to terminal J1-4. You can remove the 120VAC power wires from the J1-1 and J1-2 terminals if you like, or you can leave them there. Those terminals on the PC-3000X are non-functional, but are designed to accept the 120VAC from the legacy-PC-3000 supply power without damage.

(Continued on next page.)

9. Switch power on and go through the menus, assigning settings according to the PC-3000 settings you noted earlier. The corresponding settings between the two controllers are listed below:

PC-3000	PC-3000X
ALTERNATE	Alternation
LEAD ON	Lead Pump ON
LEAD OFF	Lead Pump OFF
LAG ON	Lag Pump ON
LAG OFF	Lag Pump OFF
LAG2 ON	Lag2 Pump ON
LAG2 OFF	Lag2 Pump OFF
HI ALARM	High Level Alarm
LO ALARM	Low Level Alarm
MAX LEVEL	Transducer Range
OFFSET	Level Offset
HOW MANY PUMPS	Number Of Pumps
START DELAY	Pump ON Delay
STOP DELAY	Pump OFF Delay
TIME AT SP	Setpoint Dwell Time

PC-3000	PC-3000X
HIGH LATCH	N/A
BACKUP TIME	Backup Float Run Time
START TEST	Aux/Dis Input Function
	Starter Run Feedback Time
SEAL	Seal Fail Polarity
TEMP	Temp Fail Reset Mode
AUX R	Aux Relay Function
MAX ON AT ONCE	Max Pumps On At Once
A OUT LOW	Analog Out Low Level
A OUT HI	Analog Out High Level
N/A	Level Units
PUMP UP/DOWN	Pumping Direction
N/A	Pump Horsepower
N/A	Pump Voltage
N/A	Pump FLA
N/A	Tank Diameter

10. Test the controller operation to be sure it works in your application.

ELECTRICAL WIRING DIAGRAM

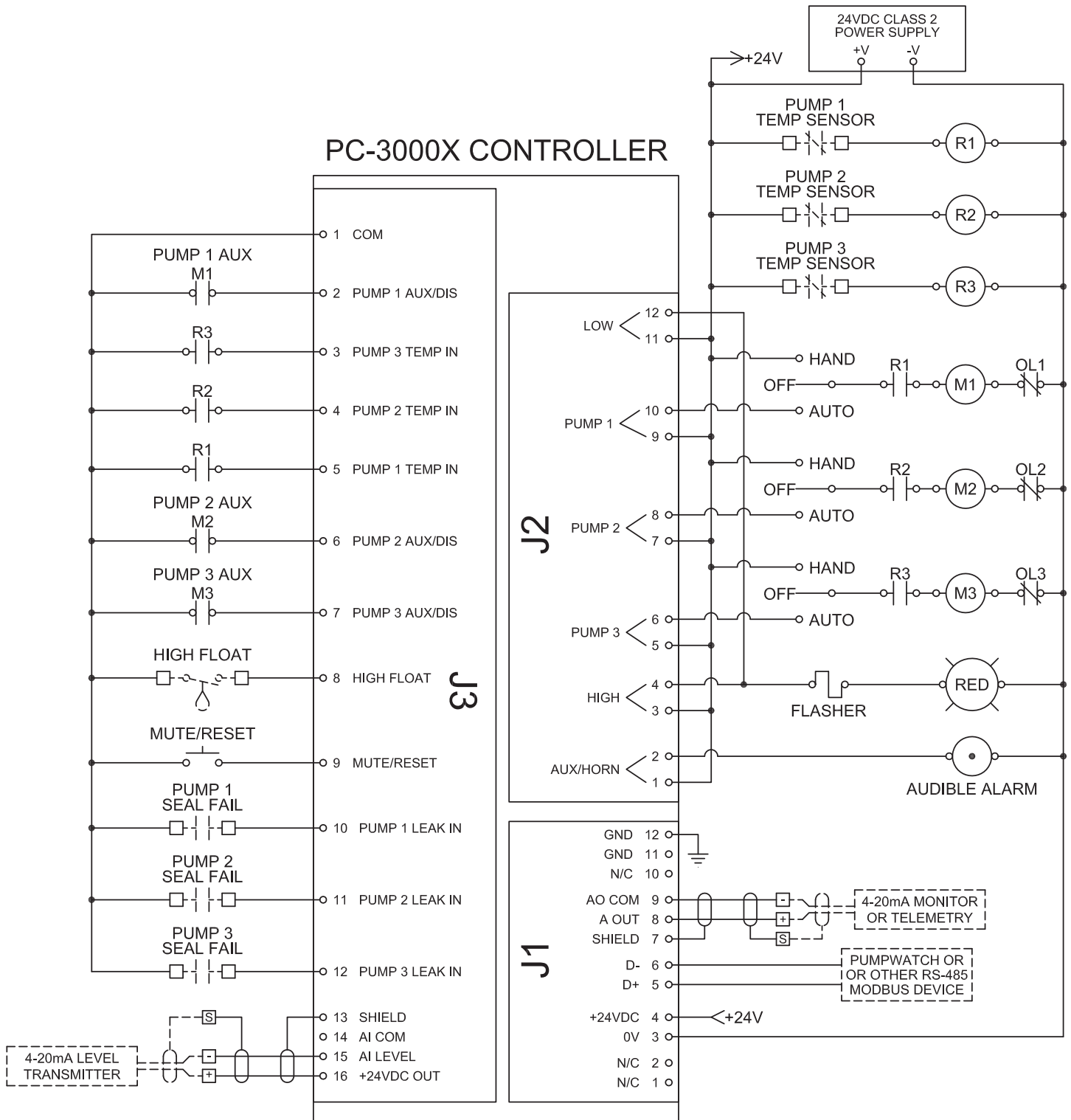

PC-3000X CONTROLLER SETPOINTS LIST

STATION NAME:	
START UP DATE:	
CONTROLLER REV:	

	MIN	MAX	DEFAULT VALUE	USER SETTING
LEVEL SETPOINTS				
Lead Pump ON	0	999.9	7.0	
Lead Pump OFF	0	999.9	4.0	
Lag Pump ON	0	999.9	8.0	
Lag Pump OFF	0	999.9	4.0	
Lag2 Pump ON	0	999.9	9.0	
Lag2 Pump OFF	0	999.9	4.0	
High Level Alarm	0	999.9	10.0	
Low Level Alarm	0	999.9	3.0	
ADVANCED SETTINGS				
Transducer Range	1.0	999.9	15.0	
Level Offset	0	999.9	1.0	
Number Of Pumps	1	3	2	
Pump ON Delay	0	250	5 sec	
Pump OFF Delay	0	250	5 sec	
Setpoint Dwell Time	0	99	2 sec	
Backup Float Run Time	0	999	0 sec	
Aux/Dis Input Function	List		Feedback	
Starter Run Feedback Time	1	99	2 sec	
Seal Fail Polarity	List		Normal	
Temp Fail Reset Mode	List		Auto-Reset	
Aux Relay Function	List		Horn	
Mute/Rst/PwrFail Function	List		Mute/Reset	
Max Pumps On At Once	1	3	2	
Analog Out Low Level	0	999.9	0.0	
Analog Out High Level	0	999.9	16.0	
Level Units	List		Feet	
Pumping Direction	List		Down	
REMOTE FAULT STATUS				
Power Fail Delay Time	0	999	20	
Max. Pump Run Time	0	99.9	0.0	
STATION DATA				
Pump Horsepower	0	999	10	
Pump Voltage	0	999	460	
Pump FLA	0	999.9	15.0	
Tank Diameter	0	999.9	6.0	
Inlet Height	0	999.9	0.0	



Warning: Users must read this manual and understand controller operation before changing any settings. Entering incorrect settings may result in damage to equipment.

If the PC-3000X controller was shipped pre-installed in a control panel, some default values may have been changed at the factory in order to properly test the control panel operation. The user must adjust the settings to the requirements of their particular installation

The user should always keep a record of the settings before making changes, in case there is a need to revert to previous settings. The user should also record all settings changed for use in programming a new controller in case a replacement is ever needed.

Always thoroughly test controller operation in the installed configuration to verify user settings.



Ashland, OH	800-363-5842
Clearwater, FL	800-349-1905
Detroit Lakes, MN	888-342-5753
Milford, OH	513-831-9959
Plymouth, MN	763-559-0568
Vacaville, CA	707-449-0341